



Coin-type Manganese Dioxide Lithium Rechargeable Battery

maxell

# ML2016 (25mAh)

## Diagrams of Batteries with Terminals

### External Dimensions (unit: mm)

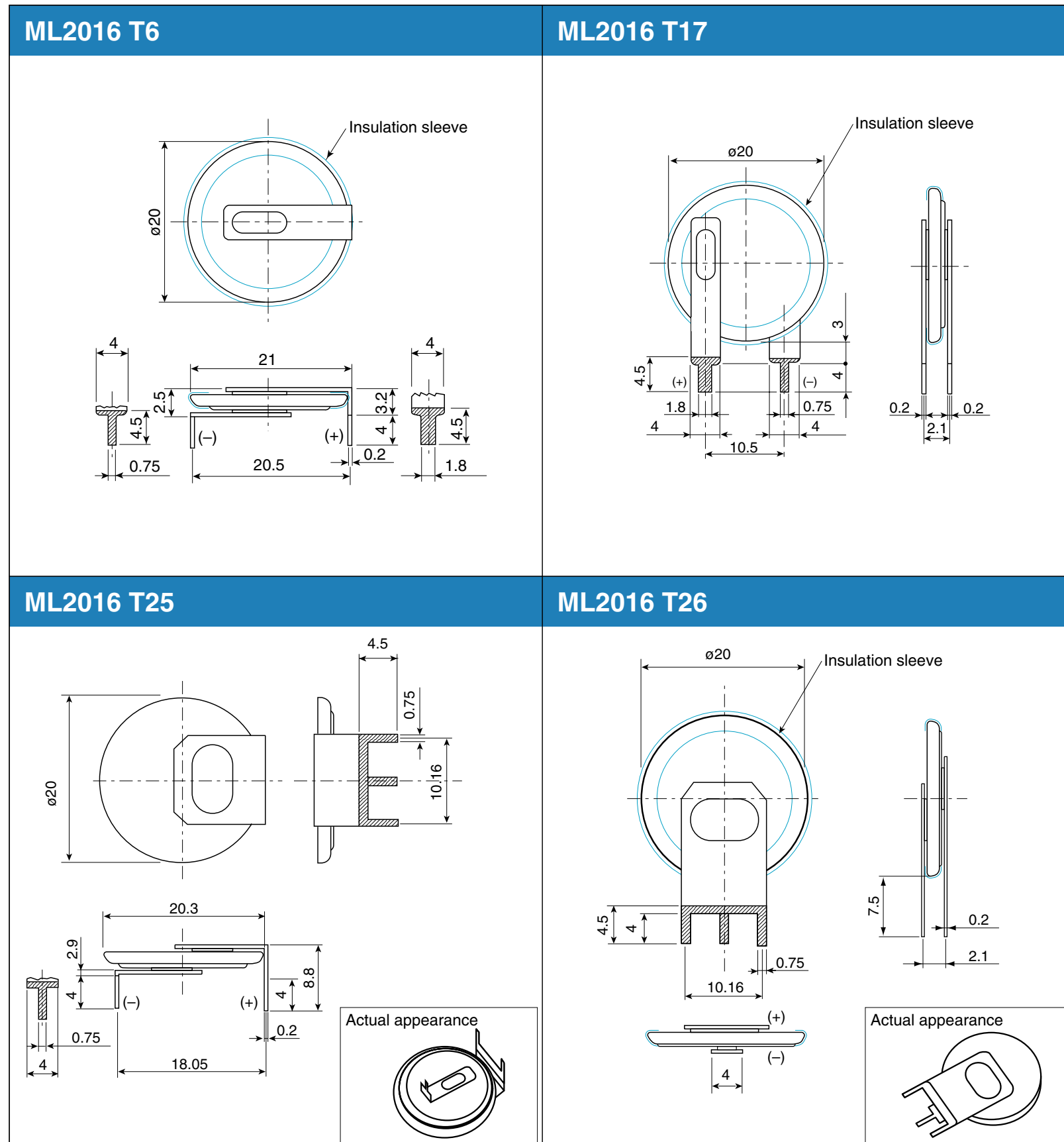
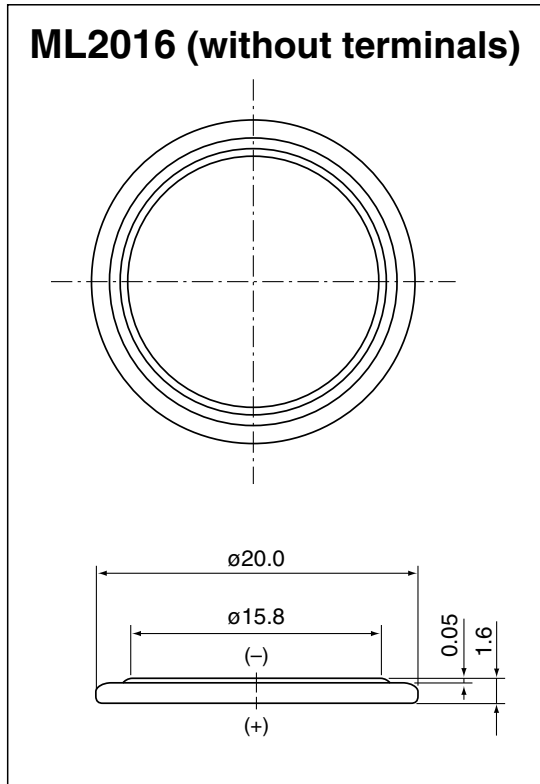

Solder plating